

SONY®

3-700-289-12(1)

LCD Digital Color TV



Operating Instructions

KDL-32L4000

KDL-37L4000

BRAVIA

Owner's Record

The model and serial numbers are located at the rear of the TV. Record these numbers in the spaces provided below. Refer to them whenever you call upon your Sony dealer regarding this TV.

Model Name _____

Serial No. _____

WARNING

To reduce the risk of fire or electric shock, do not expose this TV to rain or moisture.



This symbol is intended to alert the user to the presence of uninsulated "dangerous voltage" within the TV's enclosure that may be of sufficient magnitude to constitute a risk of electric shock to persons.



This symbol is intended to alert the user to the presence of important operating and maintenance (servicing) instructions in the literature accompanying the TV.

The TV shall not be exposed to dripping or splashing and no objects filled with liquids, such as vases, shall be placed on the TV.

Antenna grounding according to the National Electrical Code, ANSI/NFPA 70

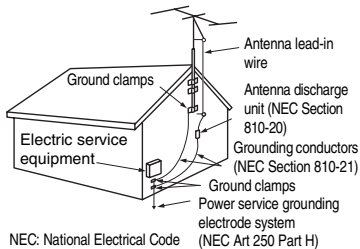

NEC: National Electrical Code

CAUTION

To prevent electric shock and blade exposure, do not use this polarized AC plug with an extension cord, receptacle or other outlet unless the blades can be fully inserted.

Declaration of Conformity

Trade Name: SONY
 Model: KDL-32L4000/KDL-37L4000
 Responsible Party: Sony Electronics Inc.
 Address: 16530 Via Esprillo,
 San Diego, CA 92127 U.S.A.
 Telephone Number: 858-942-2230

This device complies with part 15 of the FCC rules. Operation is subject to the following two conditions: (1) This device may not cause harmful interference, and (2) this device must accept any interference received, including interference that may cause undesired operation.

NOTIFICATION

This equipment has been tested and found to comply with the limits for a Class B digital device, pursuant to Part 15 of the FCC Rules. These limits are designed to provide reasonable protection against harmful interference in a residential installation. This equipment generates, uses and can radiate radio frequency energy and, if not installed and used in accordance with the instructions, may cause harmful interference to radio communications. However, there is no guarantee that interference will not occur in a particular installation. If this equipment does cause harmful interference to radio or television reception, which can be determined by turning the equipment off and on, the user is encouraged to try to correct the interference by one or more of the following measures:

- Reorient or relocate the receiving antenna.
- Increase the separation between the equipment and receiver.
- Connect the equipment into an outlet on a circuit different from that to which the receiver is connected.
- Consult the dealer or an experienced radio/TV technician for help.

Pursuant to FCC regulations, you are cautioned that any changes or modifications not expressly approved in this manual could void your authority to operate this equipment.

The shielded interface cable recommended in this manual must be used with this equipment in order to comply with the limits for a digital device pursuant to Subpart B of Part 15 of FCC Rules.

For customer in Canada

This Class B digital apparatus complies with Canadian ICES-003.

Safety

- Operate the TV only on 120-240 V AC.
- Use the AC power cord specified by Sony and suitable for the voltage where you use it.
- The plug is designed, for safety purposes, to fit into the wall outlet only one way. If you are unable to insert the plug fully into the outlet, contact your dealer.
- If you will not be using the TV for several days, disconnect the power by pulling the plug itself. Never pull on the cord.
- For details concerning safety precautions, see "Important Safety Instructions" on page 3.

Installing

- The TV should be installed near an easily accessible power outlet.
- To prevent internal heat buildup, do not block the ventilation openings.
- Do not install the TV in a hot or humid place, or in a place subject to excessive dust or mechanical vibration.
- Avoid operating the TV at temperatures below 41°F (5°C).
- If the TV is transported directly from a cold to a warm location, or if the room temperature changes suddenly, the picture may be blurred or show poor color due to moisture condensation. In this case, please wait a few hours to let the moisture evaporate before turning on the TV.
- To obtain the best picture, do not expose the screen to direct illumination or direct sunlight. It is recommended to use spot lighting directed down from the ceiling or to cover the windows that face the screen with opaque drapery. It is desirable to install the TV in a room where the floor and walls are not of a reflective material.

CAUTION

Use the following Sony TVs only with the following WALL-MOUNT BRACKET or TV-stand.

Sony TV Model No.	
	KDL-32L4000 KDL-37L4000
Sony Wall-Mount Bracket Model No.	SU-WL500
Sony TV-Stand Model No.	SU-FL300M

Use with other WALL-MOUNT BRACKET or TV-stand may cause instability and possibly result in injury.

To Customers

Sufficient expertise is required for installing the specified TV. Be sure to subcontract the installation to Sony dealer or licensed contractors and pay adequate attention to safety during the installation.

Note

This television includes a QAM demodulator which should allow you to receive unscrambled digital cable television programming via subscription service to a cable service provider. Availability of digital cable television programming in your area depends on the type of programming and signal provided by your cable service provider.

Trademark Information

Macintosh is a trademark of Apple Inc., registered in the U.S. and other countries.

HDMI, the HDMI logo and High-Definition Multimedia Interface are trademarks or registered trademarks of HDMI Licensing LLC.

Manufactured under license from Dolby Laboratories. "Dolby" and the double-D symbol are trademarks of Dolby Laboratories.

Blu-ray Disc is a trademark.

"BRAVIA", BRAVIA and  are trademarks or registered trademarks of Sony Corporation.



Important Safety Instructions

- 1) Read these instructions.
- 2) Keep these instructions.
- 3) Heed all warnings.
- 4) Follow all instructions.
- 5) Do not use this apparatus near water.
- 6) Clean only with dry cloth.
- 7) Do not block any ventilation openings. Install in accordance with the manufacturer's instructions.
- 8) Do not install near any heat sources such as radiators, heat registers, stoves, or other apparatus (including amplifiers) that produce heat.
- 9) Do not defeat the safety purpose of the polarized or grounding-type plug. A polarized plug has two blades with one wider than the other. A grounding type plug has two blades and a third grounding prong. The wide blade or the third prong are provided for your safety. If the provided plug does not fit into your outlet, consult an electrician for replacement of the obsolete outlet.
- 10) Protect the power cord from being walked on or pinched particularly at plugs, convenience receptacles, and the point where they exit from the apparatus.
- 11) Only use attachments/accessories specified by the manufacturer.
- 12) Use only with the cart, stand, tripod, bracket, or table specified by the manufacturer, or sold with the apparatus. When a cart is used, use caution when moving the cart/apparatus combination to avoid injury from tip-over.



- 13) Unplug this apparatus during lightning storms or when unused for long periods of time.
- 14) Refer all servicing to qualified service personnel. Servicing is required when the apparatus has been damaged in any way, such as power-supply cord or plug is damaged, liquid has been spilled or objects have fallen into the apparatus, the apparatus has been exposed to rain or moisture, does not operate normally, or has been dropped.

(Continued)

MOISTURE

To reduce the risk of fire or electric shock, do not expose this TV to rain or moisture.

- The TV must never be exposed to dripping, splashing, or spilling liquids of any kind.
- Do not place liquid filled objects such as a vase or potted plant on the TV.
- Do not use a power line operated TV set near water; for example, near a bathtub, washbowl, kitchen sink, laundry tub, wet basement or near a swimming pool, etc.



CLEANING

When cleaning, be sure to unplug the power cord to avoid any chance of electric shock.

- Clean the cabinet of the TV with a dry soft cloth.
- Wipe the LCD screen gently with a soft cloth.
- Stubborn stains may be removed with a cloth slightly moistened with a solution of mild soap and warm water.
- If using a chemically pretreated cloth, please follow the instruction provided on the package.
- Never use strong solvents such as a thinner, alcohol or benzene for cleaning.
- Periodic vacuuming of the ventilation openings is recommended to ensure to proper ventilation.



VENTILATION

The ventilation openings in the TV are necessary to ensure reliable operation of the TV and to protect it from overheating.

- Do not block or cover the ventilation openings with cloth or other materials.
- Never place the TV on a bed, sofa, rug or other similar surface where ventilation openings may be blocked.
- Unless proper ventilation is provided, the TV may accumulate dust and cause damage.
- Never allow liquid or solid objects to fall into the ventilation openings.



- If any liquid or solid object falls inside the TV unplug the TV immediately and have it checked by qualified service personnel before operating it further.
- Never push objects of any kind into the TV through the ventilation openings as they may come in contact with dangerous voltage points or short out parts that could result in a fire or an electric shock.

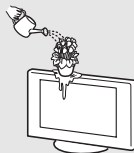

Allow adequate space around the TV set to ensure proper air circulation.

- Never place the TV in a confined space, such as a bookcase or built-in cabinet, unless proper ventilation is provided.

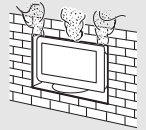

Leave some space around the TV set as shown below. Otherwise, air-circulation may be inadequate and cause overheating, which may cause a fire or damage to the TV set.

Installed on the wall

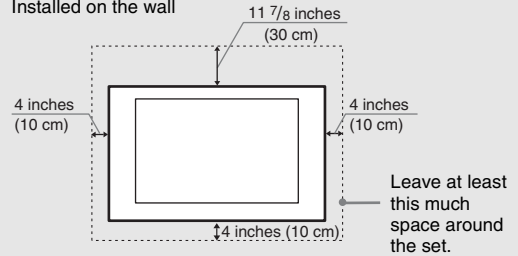

Installed with stand

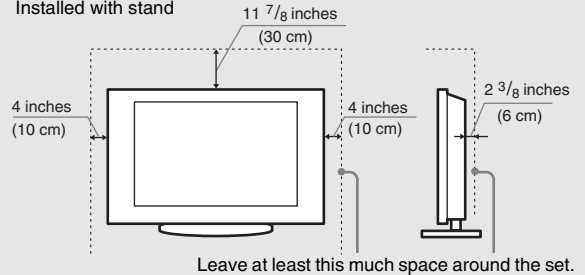

Never install the TV set as follows:

Air circulation is blocked.

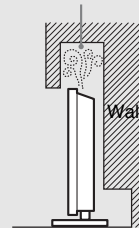

Air circulation is blocked.

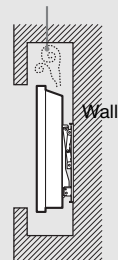

CARRYING THE TV

Carry the TV in the specified manner

To avoid dropping the TV and causing serious injury, be sure to follow these guidelines:

- Before carrying the TV, disconnect all cables.
- Carrying the large size TV requires two or more people.
- When you carry the TV, place your hand as illustrated and hold it securely. Do not put stress on the LCD panel.
- When carrying the TV, do not subject it to shocks or vibration, or excessive force.

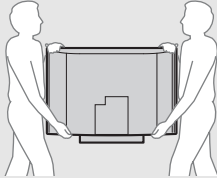

- When lifting or moving the TV, hold it firmly from the bottom. Place your palm directly underneath but do not squeeze the front panel or recessed area.

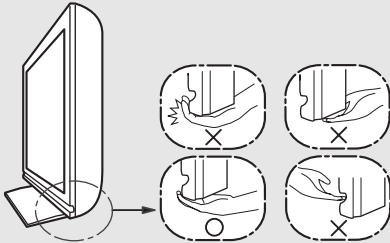

- When carrying the TV, to avoid pinching your hands or fingers do not put your hands between the TV and stand, or hold the bottom corner of the TV.

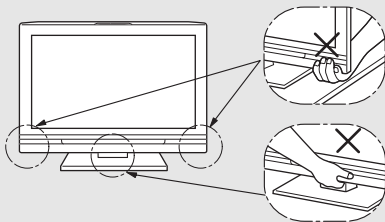

INSTALLATION

The TV should be installed near an easily accessible AC power outlet.

- Do not install the TV face up or down, upside down or on its side.
- Do not install the TV in hot, oily, humid, or excessively dusty places.
- Do not install the TV in places subject to extreme temperature, such as in direct sunlight, near a radiator or a heating vent. The TV may overheat in such conditions and can cause deformation of the enclosure and/or cause TV malfunction.



- Do not install the TV in a place exposed to direct air conditioning; moisture may condense inside and may cause TV malfunction.



- Do not install the TV where it may be exposed to mechanical vibration.
- Do not install the TV where insects may enter.
- Do not install the TV in a location where it may protrude, such as on or behind a pillar, or any place you might bump your head or receive bodily injury.
- To prevent fire keep flammable objects or open flame (e.g. candles) away from the TV.
- Do not place optional equipment on top of the TV.

Prevent the TV from toppling over

Take measures to prevent the TV from toppling over and causing injury, damage to the TV and property.



- Secure the TV to a wall and/or stand.
- Never install the TV on unstable and/or uneven surfaces.
- Do not allow children to climb on or play with furniture and TV sets.
- Do not install the TV on furniture that can easily be used as steps, such as a chest of drawers.
- Care should be taken to install the TV where it cannot be pushed, pulled over, or knocked down.
- Care should be taken to route all AC power cords and connecting cables so that they cannot be pulled or grabbed by curious children.

Medical institutions

Do not place this TV in a place where medical equipment is in use. It may cause a medical equipment malfunction.



Outdoor use

Do not install this TV outdoors. The TV should not be exposed to rain or direct sunlight in order to avoid damage and possible fire or electric shock.

Do not install this TV in a vehicle, ship or other vessel

- Excessive bumping motion of a moving vehicle or continuous swaying motion on a boat may cause the TV to fall down and cause injury.
- Exposing the TV to seawater may cause a fire, electric shock or damage to your TV.



Magnetic influence

- This TV contains a strong magnet in the speaker unit that generates a magnetic field. Keep any items susceptible to magnetic fields away from the speaker.
- Electro-magnetic radiation emitted from optional equipment installed too close to the TV may cause picture distortion and/or noisy sound.

(Continued)

Wall-mount use

- ❑ Wall-mount installation requires the use of a Wall-Mount Bracket. When installing or removing the TV and the Wall-Mount Bracket, be sure to use qualified contractors. If not properly secured during installation or removal from the Wall-Mount Bracket, the TV may fall and cause serious injury.
- ❑ Be sure to follow the installation guide supplied with the Wall-Mount Bracket when installing the TV.
- ❑ Be sure to attach the brackets with the specified parts supplied with the Wall-Mount Bracket.
- ❑ Do not hang the TV from the ceiling. It may fall and cause serious injury.
- ❑ Do not hang anything on the TV.
- ❑ Do not allow children to climb on the TV.

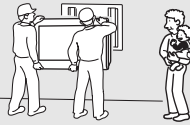

AC POWER CORD

- ❑ Do not touch the AC power cord and its plug with wet hand, it may cause electric shock.
- ❑ When disconnecting the AC power cord, grasp the plug and disconnect from the wall outlet first. Do not pull by the cord.



- ❑ Keep the power cord away from heat sources.

A TV set with a three-wire grounding type AC power cord plug must be connected to an AC power outlet with a protective earthing connection.

- ❑ Do not convert or damage the AC power cord.
- ❑ Consult your electrician to have the outlet changed to suit your TV.

Subjecting the AC power cord to wear and/or abuse can damage the AC power cord and your TV.

- ❑ Do not place the TV where the power cord can be easily pinched, bent, twisted, or catch your feet.

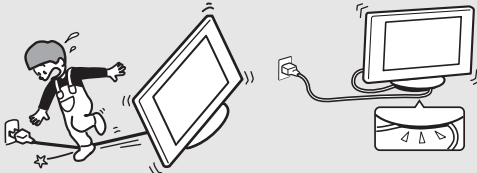

- ❑ Do not allow anything to rest on or roll over the cord.
- ❑ Before connecting cables, be sure to unplug the AC power cord for your safety.
- ❑ Do not move the TV with the AC power cord (or other cables such as audio and video) connected.
- ❑ Use only an original Sony AC power cord with your TV; no brand substitution is allowed.
- ❑ Do not use AC power cord supplied with the TV with any other equipment.

- ❑ Never use a damaged AC power cord. A damaged AC power cord can cause a short-circuit, which may result in a fire or electric shock.

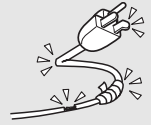

Do not use a damaged or poorly fitting AC power outlet as your TV's power source.

- ❑ Insert the plug fully into the outlet. If it is loose, it may cause arcing and result in a fire.



- ❑ Do not overload the same AC power outlet.

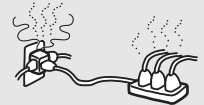

Unplugging the AC power cord from the wall outlet will completely remove power from the TV.

- ❑ During lightning storms or when the TV is left unattended and unused for extended periods of time, the AC power cord should be unplugged from the wall outlet. This will avoid possible damage to your TV. Also unplug the antenna to prevent damage to the TV.



- ❑ For energy conservation and safety reasons, practice unplugging the AC power cord from the AC power outlet.

Clean the AC power plug

Unplug the AC power plug and clean it occasionally to avoid dust from accumulating. While cleaning, look for signs of damage. A damaged AC power cord should never be used.



ACCESSORIES

Keep small accessories out of children's reach. Use only the specified accessories with this TV.

Volume Adjustment

- ❑ When using headphones, adjust the volume to avoid excessive audio levels from causing possible hearing loss.



BATTERIES

Your remote control batteries are consumables.

- ❑ To preserve our environment, dispose of used batteries according to your local laws or regulations.
- ❑ Do not dispose of batteries in a fire.
- ❑ Do not short-circuit, disassemble or overheat the batteries.
- ❑ Replace only with the same or equivalent type of batteries. Using incorrect replacement batteries can lead to an explosion.

LCD SCREEN

- Although the LCD screen is made with high-precision technology and has effective pixels of 99.99% or more, black dots or bright points of light (red, blue, or green) may appear constantly on the LCD screen. This is a structural property of the LCD panel and is not a malfunction.
- The LCD screen is made with high-precision technology and to achieve a high level of performance and picture quality, this TV's backlight setting is set to maximize the brightness of the TV. However, uneven brightness may be observed when the LCD TV is viewed in a dark ambient without an input source or blank screen. This condition is normal and not a malfunction of the TV. Changing the Picture mode, Backlight setting, enabling the Light Sensor, or turning on the Power Management will improve this condition.
- To avoid damaging the LCD panel, do not expose the LCD screen to direct sunlight.
- Do not push or scratch the LCD screen, or place objects on top of the TV. The images may be uneven or the LCD panel may be damaged.
- If the TV is used in a cold place, smear may occur in the picture or the picture may become dark. This does not indicate a failure. These phenomena improve as the temperature rises.
- Ghosting may occur when still pictures are displayed continuously. It should disappear after a few moments.
- The LCD screen and enclosure get warm when the TV is in use. This is not a malfunction.
- Avoid spraying insect repellent with volatile material on the LCD screen.
- Avoid prolonged contact with rubber or plastic material to the LCD screen.

Broken screen panel

Do not throw anything at the TV as the impact can cause the LCD screen glass to crack, break or scatter.



- If damage occurs to the LCD panel, small traces of liquid crystal sandwiched between the glass may be found on scattered broken glass.
- Do not touch the broken glass with bare hands. As with any broken glass pieces, avoid skin contact and exposure to your eyes or mouth. Avoid direct contact with liquid or damp surfaces of the glass as these may have an adverse effect on some people. The contacted area should be rinsed thoroughly with water. If conditions persist, see your doctor.
- If the surface of the TV cracks, do not touch the TV until you have unplugged the AC power cord. Otherwise electric shock may result.

SERVICING

Do not use the TV if you suspect the TV is damaged or if the TV is damaged.

- Do not attempt to service the TV yourself since opening the cabinet may expose you to dangerous voltage levels or other hazards. Refer all servicing to qualified service personnel.
- If replacement parts are required, acquire a written certification from the service technician which states that adequate replacement parts with the same or similar characteristics as the original parts have been used. Unauthorized substitutions may result in a fire, an electric shock or other hazards.

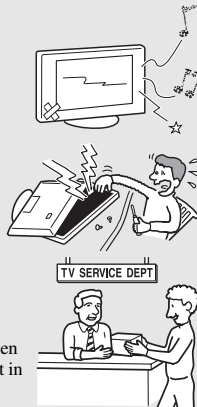

Safety check

- Upon completion of any TV servicing or repair, ask the service technician to perform routine safety checks as specified by Sony and to certify that the TV is safe to operate. Have a qualified service technician dispose of the TV if it is not safe to operate.



For customers in the United States

Lamp in this product contains mercury. Disposal of these materials may be regulated due to environmental considerations. For disposal or recycling information, please contact your local authorities or the Electronics Industries Alliance (www.eiae.org).

Contents

Getting Started

Welcome to the World of BRAVIA®	10
Assembling the Table-Top Stand	10
Connecting the TV	12
Cable System or VHF/UHF Antenna System.....	12
Cable Box/Digital Cable Box	12
Cable System and VHF/UHF Antenna System	13
Satellite Receiver and Cable/Antenna.....	13
VCR, Cable and Antenna.....	14
When Connecting to Optional Equipment	15
Securing the TV	17
Preventing the TV from Toppling.....	17
Use a Sony TV Stand.....	17
Recommended Measures to Secure the TV	17
Bundling the Connecting Cables	19
Setting Up the Channel List - Initial Setup	20

Basic Operations

Remote Control	21
TV Controls	24

Using the Menu

Overview of MENU	25
Using the Picture Settings	25
Using the Sound Settings	26
Using the Screen Settings	27
Using the PC Settings	28
Using the Channel Settings	29
Using the Parental Lock Settings	30
Using the Setup Settings	33

Other Information

Troubleshooting	35
Preparation for Wall Mounting	37
PC Input Signal Reference Chart	38
Specifications	39
Index	40

Getting Started

Welcome to the World of BRAVIA®

Thank you for purchasing this Sony LCD Digital Color Television. This manual is for model KDL-32L4000/KDL-37L4000. Be sure to check the supplied accessories against the list on page 39.

Assembling the Table-Top Stand

Follow the assembling steps required to place on a TV stand.

- 1 Take out the Table-Top Stand and screws from the carton. The screws are found in the accessory bag.

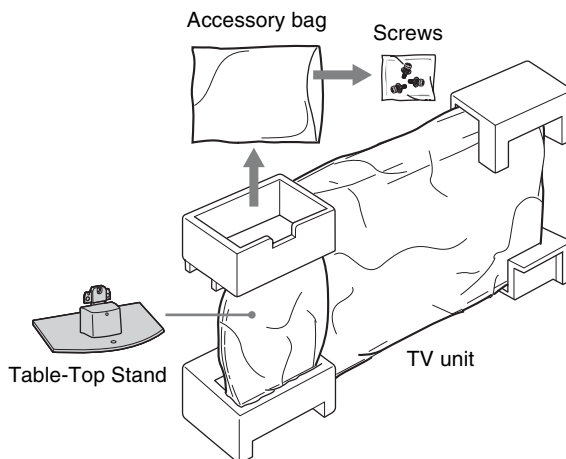

 Put your hands into the package, when taking out the TV from the carton.

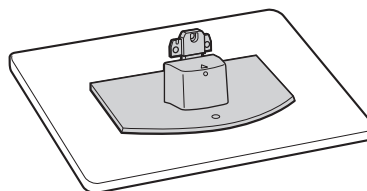

- 2 Place the Table-Top Stand onto a level and stable surface.

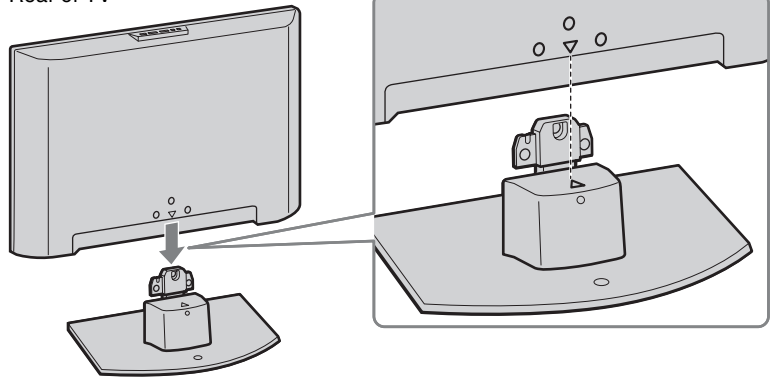

- 3** Gently slide the TV unit onto the neck of the Table-Top Stand and align the screws holes.

Rear of TV



-  Do not put stress on the LCD panel and the frame around the screen.
-  Be careful not to pinch your hands or the AC power cord when you install the TV to the Table-Top Stand.

- 4** Use the supplied screws to attach the TV unit to the Table-Top Stand.

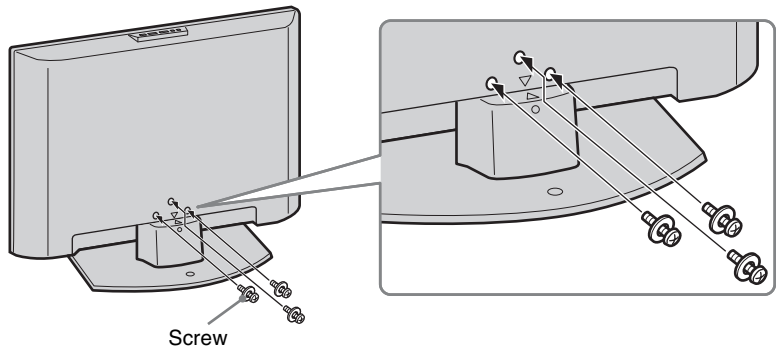

-  If an electric screwdriver is used, set the torque to tighten at approximately 1.5 N·m {15 kgf·cm}.

Connecting the TV

To display clear crisp pictures, you must connect your TV correctly and select the correct **Wide Mode** to display the picture in the correct aspect ratio (see “Changing the Wide Screen Mode” on page 22). It is strongly recommended to connect the antenna/cable input using the 75-ohm coaxial cable (not supplied) to receive optimum picture quality signal. A 300-ohm twin lead cable can be easily affected by radio noise and the like, resulting in signal deterioration. If you use a 300-ohm twin lead cable, keep it as far away from the TV as possible.

You can also connect a variety of optional equipment to your TV (see page 15). For multiple equipment connections, please refer to the Quick Setup Guide.

Cable System or VHF/UHF Antenna System

Cable or VHF/UHF (or VHF only) Antenna

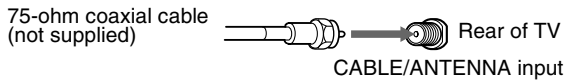

From Cable settings in Channel settings, select Cable On or Cable Off for your type of input signal.

Cable Box/Digital Cable Box

Use this hookup if

- You subscribe to a cable TV system that uses scrambled or encoded signals requiring a cable box to view all channels, and
- You do not intend to hook up any other audio or video equipment to your TV.

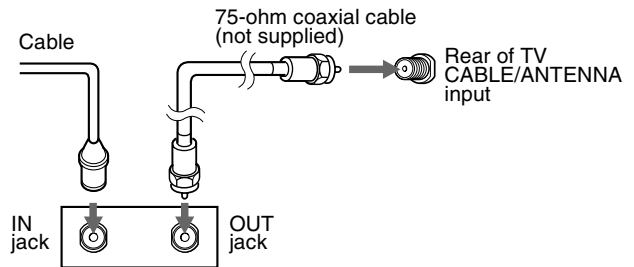

Also, set Cable to On in the Cable settings in Channel settings (see page 29).

💡 To change channels using the cable box, set your TV to channel 3 or 4 depending on the cable box channel output. Auto Program will fix the channel automatically.

Cable System and VHF/UHF Antenna System

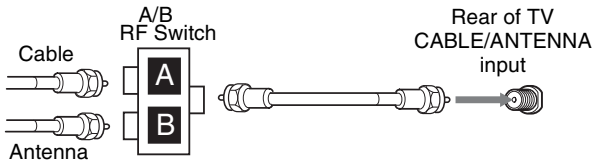

If you want to watch both antenna (over-the-air) and cable broadcast signals, you'll need to use an optional A-B RF switch (not supplied), as shown below.

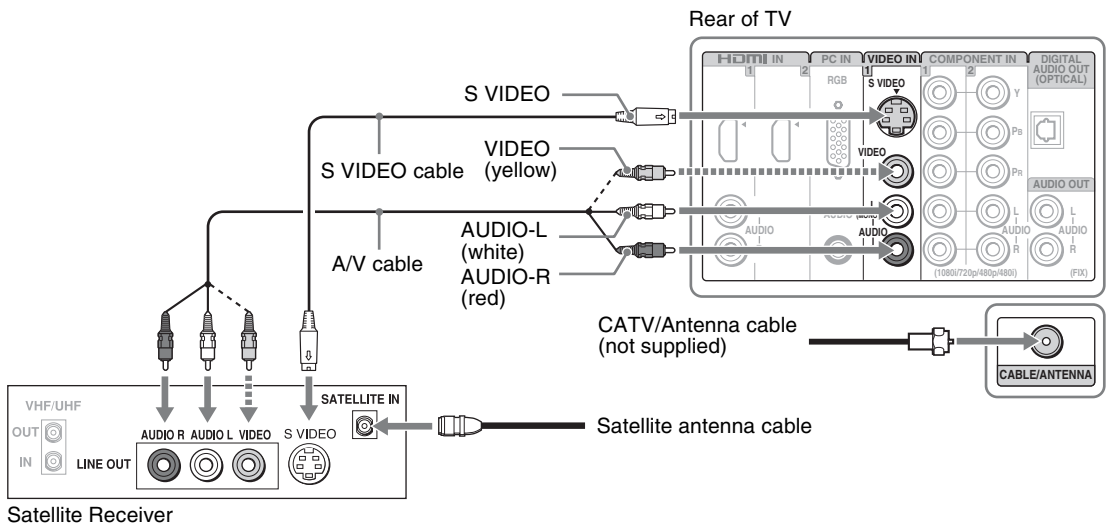

Use the A-B selector to switch between the over-the-air signals and the cable signals. Then set the Cable setting in the Channel settings to On or Off, as described on page 29.

Satellite Receiver and Cable/Antenna



-  VIDEO IN 2 is also available for a VIDEO cable connection.
-  If your satellite receiver is not equipped with S VIDEO, use a VIDEO cable (yellow) instead of the S VIDEO cable.
-  Run the Initial Setup program, as described in "Setting Up the Channel List" on page 20 after completing your connections.

VCR, Cable and Antenna

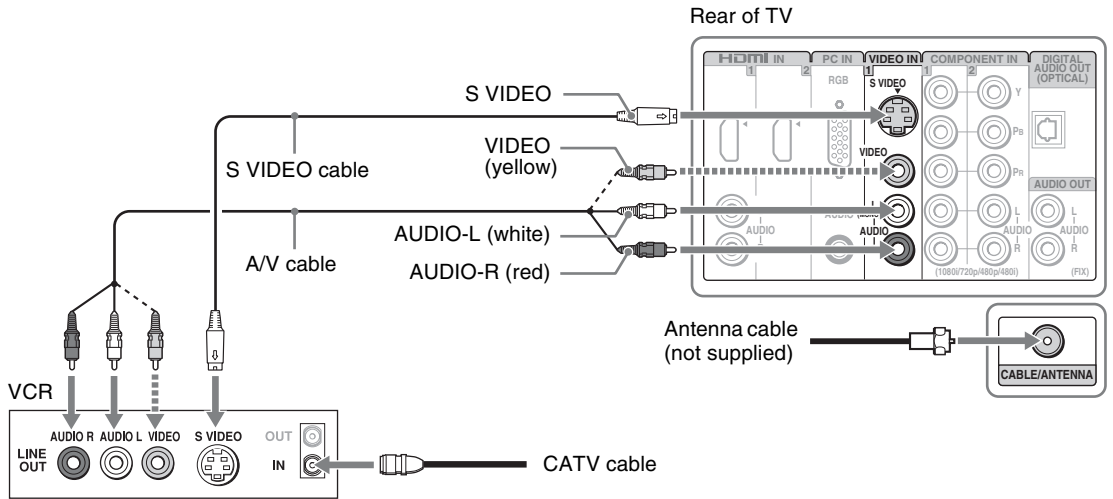

- ✎ VIDEO IN 2 is also available for a VIDEO cable connection.
- ✎ If your VCR is not equipped with S VIDEO, use a VIDEO cable (yellow) instead of the S VIDEO cable.
- ✎ Run the Initial Setup program, as described in "Setting Up the Channel List" on page 20 after completing your connections.

When Connecting to Optional Equipment

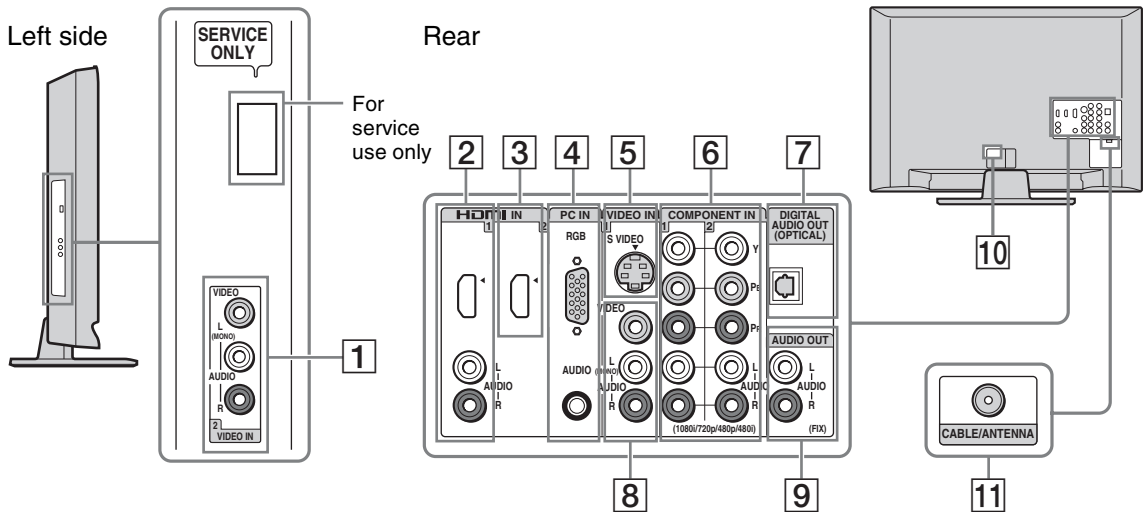

Item	Description
1	VIDEO IN 2 VIDEO/ L(MONO)-AUDIO-R  If you have mono equipment, connect its audio output jack to the TV's L (MONO) audio input jack.
2	HDMI IN 1 HDMI/ L-AUDIO-R HDMI (High-Definition Multimedia Interface) provides an uncompressed, all-digital audio/video interface between this TV and any HDMI-equipped audio/video equipment, such as a set-top box, DVD player, and A/V receiver. HDMI supports enhanced, or high-definition video, plus digital audio.
3	HDMI IN 2 If the equipment has a DVI jack and not an HDMI jack, connect the DVI jack to the HDMI IN 1 (with HDMI-to-DVI cable or adapter) jack, and connect the audio jack to the L-AUDIO-R jacks of HDMI IN 1. (DVI connector is for video signals only.)



HDMI-to-DVI cable

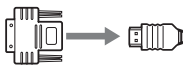

HDMI adapter

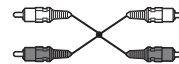



Audio cable





Do not connect a PC to the TV's HDMI input. Use the PC IN (RGB IN) input instead when connecting a PC.

(Continued)

Getting Started

Item	Description
4 PC IN (RGB/AUDIO)	<p>Connect to a personal computer's video output connector using HD15-HD15 cable (analog RGB, not supplied). Can also be connected to other analog RGB devices. See "PC Input Signal Reference Chart" on page 38 for the signals that can be displayed.</p> <p> For some Apple Macintosh computers, it may be necessary to use an adapter (not supplied). If this is the case, connect the adapter to the computer before connecting the HD15-HD15 cable.</p> <p> If the picture is noisy, flickering or not clear, adjust the Phase and Pitch of the PC Settings on page 28.</p>
5 VIDEO IN 1 S VIDEO	Connects to the S VIDEO output jack on your camcorder or other video equipment that has S VIDEO. Provides better picture quality than composite video (1 / 8).
8 VIDEO IN 1 VIDEO/L(MONO)-AUDIO-R	Connect to the composite video and audio output jacks on your A/V equipment such as a VCR or other video equipment. A second composite video and audio (VIDEO 2) is located on the left side panel of the TV.
6 COMPONENT IN 1/2 (1080i/720p/480p/480i)/L-AUDIO-R	Connect to your DVD player's or digital set-top box's component video (YPbPr) and audio (L/R) jacks. Component video provides better picture quality than the S VIDEO (5) and the composite video (1 / 8) connections.
7 DIGITAL AUDIO OUT (OPTICAL)	Connects to the optical audio input of a digital audio equipment that is PCM/Dolby digital compatible.
9 AUDIO OUT L-AUDIO-R (FIX)	Connect to the left and right audio input jacks of your audio or video equipment. You can use these outputs to listen to your TV's audio through your stereo system.
10 AC IN	Connects the supplied AC power cord.
11 CABLE/ANTENNA	RF input that connects to your Cable or VHF/UHF antenna.

* Manufactured under license from Dolby Laboratories. "Dolby" and the double-D symbol are trademarks of Dolby Laboratories.

-  VIDEO IN 1 is equipped with S VIDEO. S VIDEO will be selected when both composite video and S VIDEO are connected.
-  Component video (YPbPr) connection is necessary to view 480i, 480p, 720p, and 1080i formats. Note that this TV displays all picture format types in a resolution of 1,366 dots × 768 lines.
-  HDMI connection is necessary to view 480i, 480p, 720p, 1080i and 1080p formats. Note that this TV displays all picture format types in a resolution of 1,366 dots × 768 lines.

Securing the TV

Sony strongly recommends taking measures to prevent the TV from toppling over; as unsecured TVs may topple and result in property damage, serious bodily injury or even death.

Preventing the TV from Toppling

- Secure the TV to a wall and/or stand.
- Do not allow children to play or climb on furniture and TV sets.
- Avoid placing or hanging items on the TV.
- Never install the TV on:
 - slippery, unstable and/or uneven surfaces.
 - furniture that can easily be used as steps, such as a chest of drawers.
- Install the TV where it cannot be pulled, pushed, or knocked over.
- Route all AC power cords and connecting cables so that they are not accessible to curious children.

Use a Sony TV Stand

Use a Sony specified TV stand (see page 2) and follow the instruction manual provided with the Sony TV stand.

If a Sony specified TV stand is not used, consider the following recommended measures.

Recommended Measures to Secure the TV

1 Secure the Stand for the TV.

Make sure the TV stand can adequately support the weight of the TV. Use two angle braces (not supplied) to secure the stand.

For each angle brace use the appropriate hardware to:

- attach one side of the angle brace to the wall stud.
- attach the other side to the TV stand.

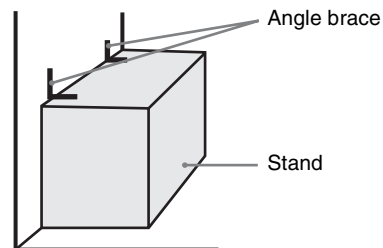

(Continued)

2 Secure the TV to the Stand.

Use the optional hardware listed below (not supplied):

- M6 × 12-18mm anchor bolt (screwed into the TV's Table-Top Stand).
- A screw or similar (attach it to the TV stand).
- Rope or chain (strong enough to support the weight of the TV). Make sure that there is no excess slack in the rope or chain.

An alternative way to secure the TV is with an optional Sony Support Belt Kit.

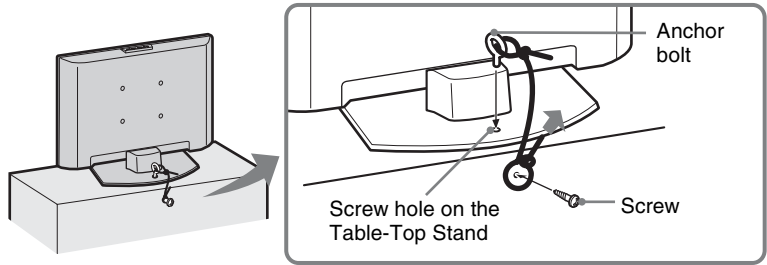

 Contact Sony Customer Support to obtain the optional Support Belt Kit by providing your TV model name.

- For United States call: 1-800-488-7669 or visit: www.sony.com/accessories
- For Canada call: 1-877-899-7669

3 Anchor the TV to the Wall.

Use the hardware listed below (not supplied).

- Two M6 × 12-18mm anchor bolts (screw into the top-most wall-mount holes located on the rear of the TV).
- Rope or chain (attach to one M6 anchor bolt).
- Wall-anchor (attach to the wall stud) strong enough to support the weight of the TV (pass the rope through the wall-anchor, then attach to the other M6 anchor bolt).

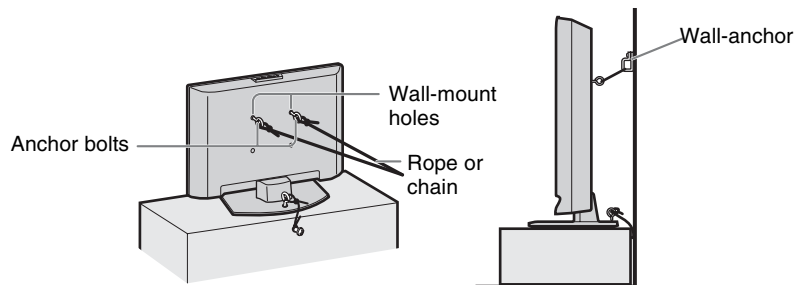

 Measure 2 provides minimal protection against the TV toppling over. For further protection, follow all three measures recommended above.

 If an electric screwdriver is used, set the torque to tighten at approximately 2.0 N·m {20 kgf·cm}.

Bundling the Connecting Cables

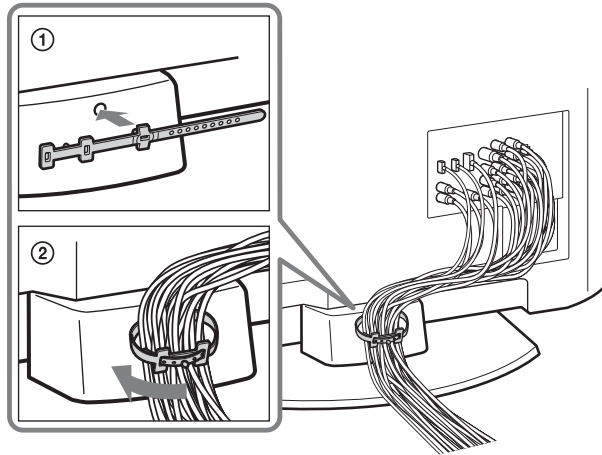

You can bundle the connecting cables with the supplied cable band as illustrated below.



 Do not bundle the AC power cord with other connecting cables.

Setting Up the Channel List - Initial Setup

After you finish connecting your TV, you need to run **Initial Setup**, which automatically sets up available channels. The **Initial Setup** screen appears when you turn on your TV for the first time. If you do not want to set up the channels at this time, you can do it later by selecting the **Auto Program** option in the **Channel** settings (see page 29).

- 1 Press  to turn on the TV.
The **Initial Setup** screen appears.
- 2 Press  to highlight the desired language.
- 3 The message “First please connect cable or antenna. Allow 50+ minutes for completion.” and “Start auto program now?” appear, make sure you already connected cable or antenna, then select **OK** to start **Auto Program**. If you want to start **Auto Program** later, select **Cancel**.

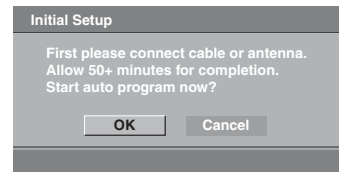
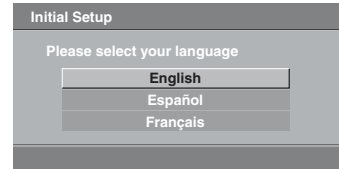

 If you have cable and antenna available, please connect cable first.

- 4 The scanning of channels will start. If you want to stop and run **Auto Program** later, press **Cancel**.
- 5 When **Auto Program** is complete, press  to continue.
- 6 If the **Initial Setup** programming found cable channels, you will be able to scan antenna channels as well. Connect the antenna using an A-B RF switch (not supplied) and change the switch to antenna then start **Auto Program** to search antenna channels.
If the **Initial Setup** programming found antenna channels, the **Auto Program** process will finish. If you want to scan cable channels, you can do it later using the **Channel** settings.

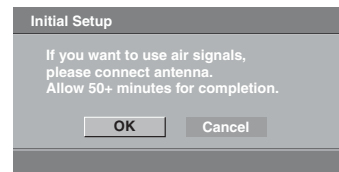
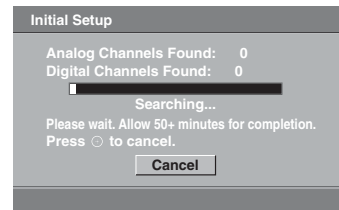

To run **Auto Program** again at a later time

- ❑ Use the **Auto Program** feature as described on page 29.

To display the **Picture** in your Preferred Aspect Ratio

- ❑ Select the proper **Wide Mode** as described on pages 22 and 27.

Basic Operations

Remote Control

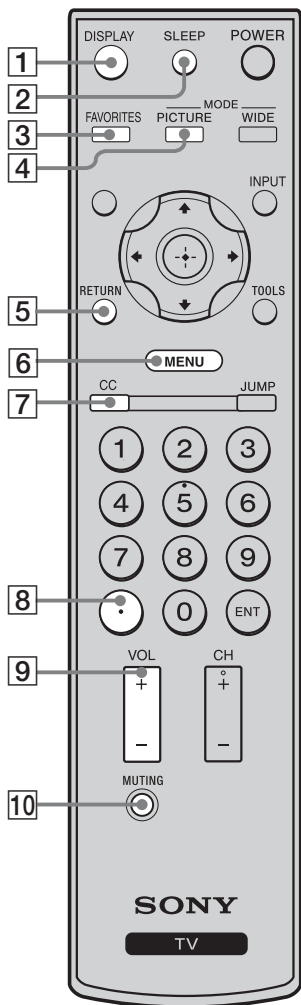

The 5 button and CH + have a tactile dot. Use them as a reference when operating the TV.

Button	Description
1 DISPLAY	Press once to display the current channel number, channel label, program remaining time and Wide Mode . The on-screen display (OSD) will turn off after a few seconds.
2 SLEEP	Press repeatedly until the TV displays the time in minutes (Off, 15, 30, 45, 60, 90 or 120) that you want the TV to remain on before shutting off. To cancel Sleep Timer, press SLEEP repeatedly until Off appears.
3 FAVORITES	Press once to display the stored Favorites list. You can store up to 8 channels and/or external inputs in your Favorites list. How to Add to Favorites While tuned to the channel you want to add to the list, press FAVORITES and highlight “Add to Favorites”, then press . Your Favorites list will be cleared each time you run Auto Program (see pages 20 and 29 for Auto Program).
4 PICTURE	Press repeatedly to cycle through the available picture modes: Vivid , Standard , Custom . The picture modes can also be accessed in the Picture settings. For details, see “Using the Picture Settings” on page 25.
5 RETURN	Press to go back to the previous screen when displaying MENU items and settings.
6 MENU	Press to display the MENU with TV functions and settings. See “Overview of MENU” on page 25.
7 CC	Press to turn on and off Closed Captions (CC) . To change or customize CC Display, see page 34.
8	Use with 0-9 and ENT buttons to select digital channels. For example, to enter 2.1, press , , and ENT .
9 VOL +/-	Press to adjust the volume.
10 MUTING	Press to mute the sound. Press again or press VOL + to restore the sound.

(Continued)



Button	Description
--------	-------------

- | | |
|----|---|
| 11 | POWER
Press to turn on and off the TV. |
| 12 | WIDE
Press repeatedly to step through the Wide Mode settings: Wide Zoom, Normal, and Full. The Wide Mode settings can also be accessed in the Screen settings. (See page 27.) |

Changing the Wide Screen Mode

(For PC timing, see below)

4:3 Original source Standard definition source	16:9 Original source High definition source
↓	↓
Wide Zoom 	Wide Zoom
Normal 	Normal This mode is not available
Full 	Full
<p> Normal is not available when you are watching a 720p or 1080i source from a component video input or a 720p, 1080i or 1080p source from an HDMI input or a digital TV.</p>	

Changing the Wide Screen Mode for PC Timing

Incoming PC signal 800 × 600	Incoming PC signal 1280 × 768
↓	↓
Normal 	Normal
Full 1 	Full 1
Full 2 	Full 2

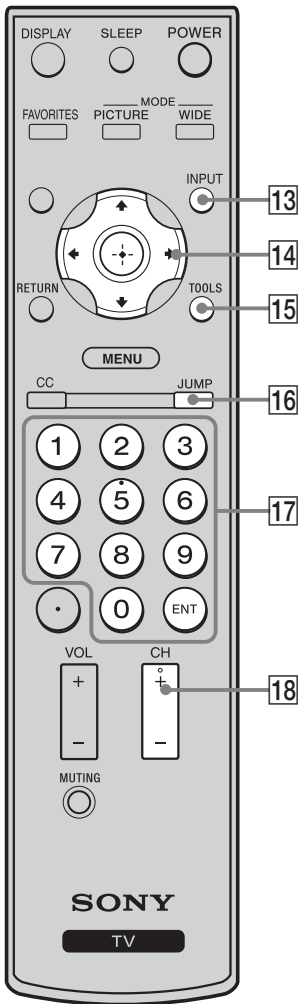

Button	Description
13 INPUT	Press to display the list of external inputs. Press repeatedly to toggle through the inputs. Inputs can be changed by pressing \uparrow/\downarrow and \oplus while the list of external inputs is displayed. See page 33 for information about setting up the external inputs labels, including the Skip feature.
14 $\uparrow/\downarrow/\leftarrow/\rightarrow$ \oplus	Press $\uparrow/\downarrow/\leftarrow/\rightarrow$ to move the on-screen cursor. Press \oplus to select/confirm an item.
15 TOOLS	Press to display the Tools Menu that is associated with your current input: analog TV, digital TV or external inputs. (See pages 25, 26, 30, and 34)
16 JUMP	Press to jump back and forth between two channels. The TV alternates between the current channel and the last channel that was selected.
17 0 - 9 ENT	Press 0 - 9 to select a channel; the channel changes after two seconds. Press ENT to change channels immediately.
18 CH +/-	Press to scan through channels. To scan quickly through channels, press and hold down either +/-.

Insert two size AA batteries (supplied) by matching the \oplus and \ominus on the batteries to the diagram inside the remote control's battery compartment.

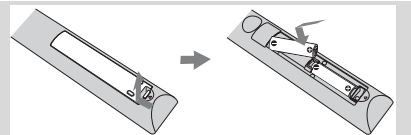

TV Controls

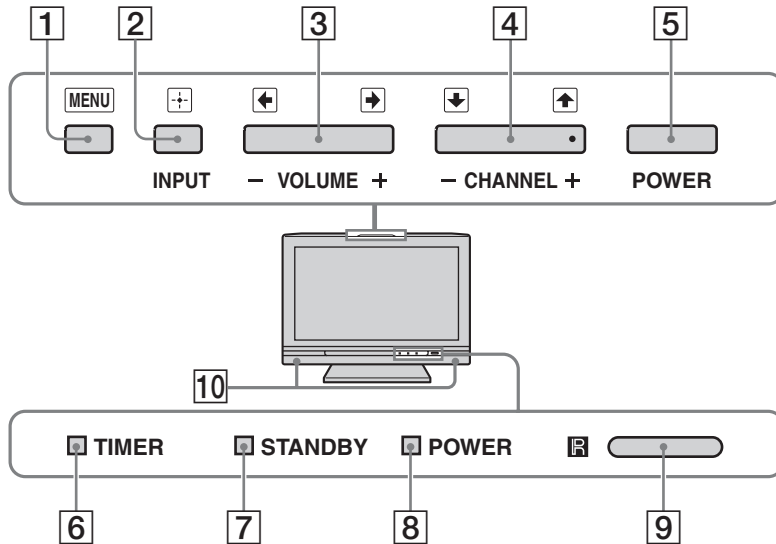

Item	Description
1 MENU	Press to display MENU with TV functions and settings (see “Overview of MENU” on page 25).
2 INPUT	Press to display the list of external inputs. Press repeatedly to toggle through the inputs. Inputs can be changed by pressing and while the list of external inputs is displayed. See page 33 for information about setting up the external inputs labels, including the Skip feature. In the MENU screen, this button serves as confirming the selection or setting.
3 - VOLUME +	Press to adjust the volume. In the MENU screen, these buttons serve as left/right buttons.
4 - CHANNEL +	Press to scan through channels. To scan quickly through channels, press and hold down either -/+ . In the MENU screen, these buttons serve as up/down buttons.
5 POWER	Press to turn on and off the TV.
6 TIMER LED	Lights up in orange when the sleep timer is set.
7 STANDBY LED	Lights up in red when your TV is in PC power saving mode.
8 POWER LED	Lights up in green when the TV is turned on.
9 (IR) Infrared Receiver	Receives IR signals from the remote control.
10 Speaker	Outputs audio signal.

- The CHANNEL + button has a tactile dot. Use it as a reference when operating the TV.
- Make sure that the TV is completely switched off before unplugging the power cord.



Using the Menus

Overview of MENU

MENU provides one button access for controlling your TV. It enables you to perform a variety of tasks intuitively with a control panel on the screen rather than a variety of remote control button presses.

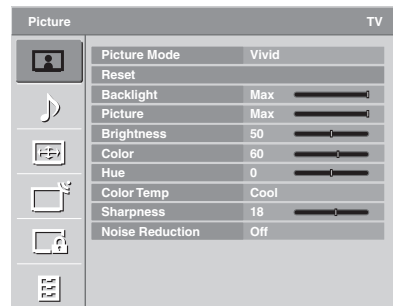
Using the Picture Settings



Option	Description
Picture Mode	Vivid Select for enhanced picture contrast and sharpness.
Customized picture viewing	Standard Select for standard picture settings. Recommended for home entertainment.
	Custom Allows you to store your preferred settings.
	 You can also access Picture Mode by using the TOOLS button or PICTURE button on the remote control.
Reset	Resets the current Picture Mode settings to the default values.
Backlight	Adjust to brighten or darken the backlight.
Picture	Adjust to increase or decrease picture contrast.
Brightness	Adjust to brighten or darken the picture.
Color	Adjust to increase or decrease color intensity.
Hue	Adjust to increase or decrease the green tones.
Color Temp White adjustment	Cool Select to give the white colors a bluish tint.
	Neutral Select to give the white colors a neutral tint.
	Warm Select to give the white colors a reddish tint.
Sharpness	Adjust to sharpen or soften the picture.
Noise Reduction	Select to reduce the noise level. Select from High, Medium, Low and Off.
	 Noise Reduction is not available when you are watching a 1080i or 1080p source.

Using the Sound Settings

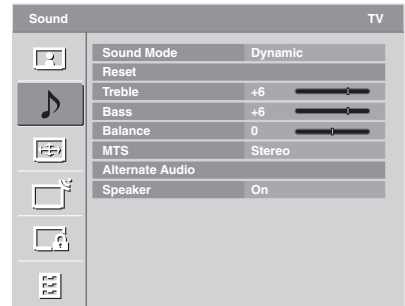



Option	Description
Sound Mode	Dynamic Enhances treble and bass.
<i>Customized sound listening</i>	Standard Standard sound optimized for home use.
	Clear Voice Suitable for spoken dialog.
	Reset Resets the current Sound Mode settings to the default values.
Treble	Adjust to increase or decrease higher-pitched sounds.
Bass	Adjust to increase or decrease lower-pitched sounds.
Balance	Adjust to emphasize left or right speaker balance.
MTS <i>Enjoy stereo, bilingual and mono programs</i>	Stereo Select for stereo reception when viewing a program broadcast in stereo.
	Auto SAP Select to automatically switch the TV to second audio programs when a signal is received. If no SAP signal is present, the TV remains in Stereo mode.
	Mono Select for mono reception. Use to reduce noise during weak stereo broadcasts.
MTS is only available for analog programs.	
Alternate Audio <i>Digital channels only</i>	Select among the available options to switch among the alternate audio streams. The program you are tuned to may be broadcasted in a different language in the alternate audio streams.
	Alternate Audio is not available if the program is not broadcast with alternate audio streams.
Speaker	On Select to turn on the TV speakers.
	Off Select to turn off the TV speakers and listen to the TV's sound only through your external audio receiver and speakers.

You can also access Sound Mode, MTS and Alternate Audio by using the **TOOLS** button on the remote control.

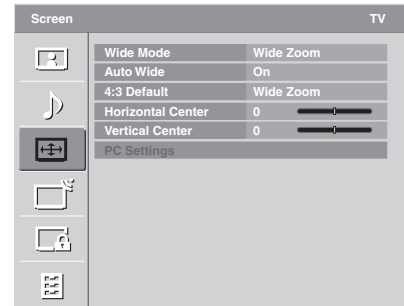
Using the Screen Settings



Option	Description
Wide Mode	Wide Zoom Fills the screen with minimum distortion.
	Normal Select to display 4:3 picture in original size when the original source is 4:3.
	Full Select to enlarge the picture horizontally to fill the screen when the original source is 4:3 (Standard definition source). When the original source is 16:9 (High definition source), select this mode to display 16:9 picture in original size.
	 Normal is not available when you are watching a 720p or 1080i source from a component video input or a 720p, 1080i or 1080p source from an HDMI input or a digital TV.
Auto Wide	On Select to have the screen automatically change to the screen mode that is best for the current program. If frequent screen changes are disturbing to you, select Off.
	Off Select to turn off the Auto Wide option. Choose a screen mode from the Wide Mode option.
	 Auto Wide is not available when you are watching analog TV.
4:3 Default <i>Select the default Screen Mode to use for 4:3 sources</i>	Wide Zoom Enlarges the 4:3 picture to fill the 16:9 screen, displaying as much of the original image as possible.
	Normal Select to display the 4:3 picture in its original size.
	Full Select to enlarge the 4:3 picture horizontally only, to fill the display area.
	Off Select to continue using the current Wide Mode setting when the channel or input is changed.
	 If 4:3 Default is set to anything but Off, the Wide Mode setting changes only for the current channel. When you change channels (or inputs), Wide Mode is automatically replaced with the 4:3 Default setting for 4:3 sources. To retain the current Wide Mode setting as channels and inputs are changed, set 4:3 Default to Off.

(Continued)



Using the Menus

Option	Description
Horizontal Center	Allows you to move the position of the picture left and right (Available only in Wide Zoom).  Horizontal Center feature is useful if TV is connected to game equipment.
Vertical Center	Allows you to move the position of the picture up and down (Available only in Wide Zoom).

Using the PC Settings

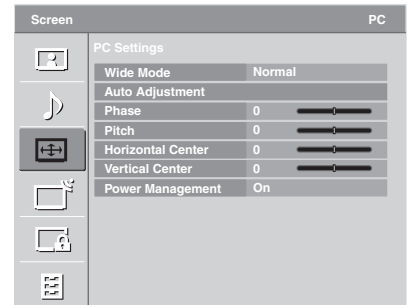



When a PC is connected to the TV and the PC input is selected, the PC Settings screen appears instead of the Screen settings.

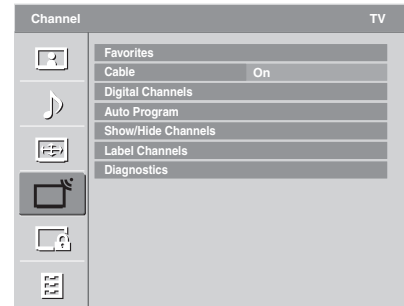

Option	Description
Wide Mode	Normal Select to display in the original image size.
	Full1 Select to enlarge the picture to fill the display area, keeping its original aspect ratio.
	Full2 Select to enlarge the picture to fill the display area.
Auto Adjustment	Select to automatically adjust the display position and phase of the picture when the TV receives an input signal from the connected PC. Note that Auto Adjustment may not work well with certain input signals. In such cases, manually adjust the options below.
Phase	Adjust after Pitch to fine tune overall sharpness.
Pitch	Adjust uneven sharpness on screen.
	 For the PC Input Signal Reference Chart, see page 38.
Horizontal Center	Allows you to move the position of the picture left and right.
Vertical Center	Allows you to move the position of the picture up and down.
Power Management	On Select to automatically switch to the power saving mode when there is no signal input for 30 seconds.
	Off Select to turn off Power Management.
	 Power Management is not VESA-compliant.

Using the Channel Settings





Option	Description
Favorites	Select favorite channels and external inputs (see page 21).
Cable	<p>On Select if you are receiving cable channels via Cable TV provider.</p> <p>Off Select if you are using an antenna.</p> <p> You should run Auto Program after changing the Cable setting.</p>
Digital Channels	Select to add digital channels.
Auto Program	<p>Automatically sets up the channel list on the TV for all receivable channels.</p> <ol style="list-style-type: none"> Select Auto Program. Select OK to start Auto Program. <p> Running Auto Program will clear Favorites list.</p>
Show/Hide Channels	<p>Allows you to show or hide channels that appear when you use the CH +/- buttons.</p> <ol style="list-style-type: none"> Press \uparrow/\downarrow to scroll through the channels until you find the channel you want to show or hide. Then press \oplus to select it. Press \uparrow/\downarrow to determine if the channel will be shown or hidden. Then press \oplus to select it. <p> Channels that you set to be hidden can be accessed only with the 0-9 buttons.</p> <p> You can set channels to be hidden that are automatically set in Auto Program.</p>
Label Channels	<p>Allows you to assign labels (such as station call letters) to channel numbers.</p> <ol style="list-style-type: none"> Press \uparrow/\downarrow to scroll through the channel numbers. Then press \oplus to select the channel number that you want to assign a label. Press \uparrow/\downarrow to scroll through the label characters (A-Z, 0-9, etc.). Press \rightarrow to move to the next character. Repeat to add up to 7 characters to the label. Press \rightarrow to highlight OK and press \oplus to set.
Diagnostics	Display diagnostics information about the TV. This can be useful in providing information to an authorized technician or repair person.

Using the Parental Lock Settings

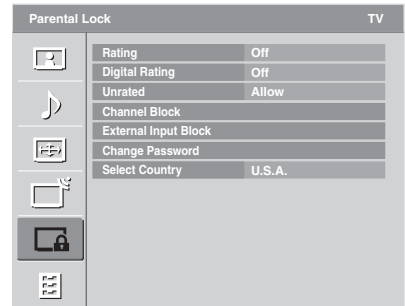
The Parental Lock settings allows you to set up the TV to block programs according to their content and rating levels. Use 0-9 on the remote control to enter a four-digit password. The first time you create a password, confirm the password by entering it again.



Option	Description
Rating	Off Turn Parental Lock off. No programs are blocked from viewing.
	Child Maximum ratings permitted are: U.S.: TV-Y, TV-G, G Canada: C, G, TV-Y
	Youth Maximum ratings permitted are: U.S.: TV-PG, PG Canada: C8+, PG, 8 ans+, TV-PG
	Young Adult Maximum ratings permitted are: U.S.: TV-14, PG-13 Canada: 14+, 13 ans+, TV-14
	Custom Select to set ratings manually. U.S.: See page 31 for details. Canada: See page 32 for details.
Digital Rating <i>(Available only in U.S.A. where advanced ratings exist)</i>	Off Turn Parental Lock off. No programs that contain downloadable ratings are blocked from viewing.
	Custom Select to block programs based on downloadable ratings.
	Clear All Select to clear the entire downloadable rating system.  This action will delete the current Digital Rating menu and the menu will no longer be available until the TV is tuned to a channel that contains downloadable ratings.
Unrated <i>(Available only when Country is set to U.S.A.)</i>	Allow Allows programs and movies that are broadcasted without a rating.
	Block Blocks all programs and movies that are broadcasted without a rating.  If you block unrated TV programs, be aware that the following types of programs may be blocked: programs broadcasted from another country, emergency broadcasts, political programs, sports, news, public service announcements, religious programs and weather.
Channel Block	Allows you to block channels regardless of program ratings. To View a Blocked Channel Press ENT when tuned to the blocked channel then enter the password.
External Input Block	Allows you to block external inputs regardless of program ratings. To View a Blocked External Input Press ENT when tuned to the blocked input then enter the password.

Option	Description
Change Password	Select to change your password.
 You need your password for any future access into the Parental Lock settings. If you lose your password, see "Lost password." on page 36.	
Select Country	U.S.A. Select to use U.S.A. ratings (see below).
	Canada Select to use Canadian ratings (see page 32).

US Models: Selecting Custom Parental Lock Rating Options

To select custom rating options for the U.S., select U.S.A. in the Select Country setting (see above).

Option	Description	
Movie Rating	G All children and general audience.	
	PG Parental guidance suggested.	
	PG-13 Parental guidance for children under 13.	
	R Restricted viewing, parental guidance is suggested for children under 17.	
	NC-17 and X No one 17 or under allowed.	
TV Rating	Age-Based Ratings	
<i>Block programs by their rating, content or both</i>	TV-Y All children.	
	TV-Y7 Directed to children age 7 and older.	
	TV-G General audience.	
	TV-PG Parental guidance suggested.	
	TV-14 Parents strongly cautioned.	
	TV-MA Mature audience only.	
	Content-Based Ratings	
	FV Fantasy violence.	
	D Suggestive dialogue.	
	L Strong language.	
S Sexual situations.		
V Violence.		
 To ensure maximum blocking capability, set the Age-Based Ratings.		

(Continued)

Using the Menus

Canadian Models: Selecting Custom Parental Lock Rating Options

To select custom rating options for Canada, select **Canada** in the **Select Country** setting (see page 31).

<i>Option</i>	<i>Description</i>
English Rating	C All children.
	C8+ Children 8 years and older.
	G General programming.
	PG Parental guidance.
	14+ Viewers 14 and older.
	18+ Adult programming.
French Rating	G General programming.
	8 ans+ Not recommended for young children.
	13 ans+ Not recommended for ages under 13.
	16 ans+ Not recommended for ages under 16.
	18 ans+ Programming restricted to adults.
U.S.A. Rating	See "US Models" on page 31 for details.

Viewing Blocked Programs

You can view blocked programs by entering the password. Press **ENT** when tuned to a blocked program, then enter the password. This temporarily turns the parental control feature off. To reactivate the **Parental Lock** settings, turn off the TV. When the TV is turned on again, your **Parental Lock** settings are reactivated.

Using the Setup Settings

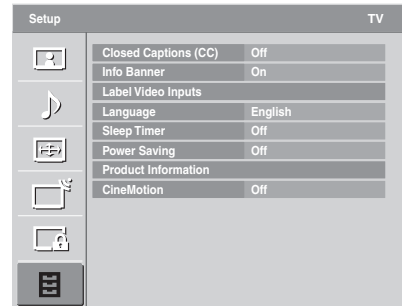

Option	Description	
Closed Captions (CC)	Allows you to select from several closed caption modes (for programs that are broadcast with closed captioning).	
	On	Closed Captions (CC) is turned on.
	Off	Closed Captions (CC) is turned off.
	Program	Allows you to set basic and advanced Closed Captions (CC) options. See “Programming Closed Captions (CC)” on page 34.
	You can also access Closed Captions (CC) by using the CC button on the remote control when in analog TV, digital TV and external inputs (with the exception of PC input).	
Info Banner	Set to On or Off . When on, displays the program description and the remaining time (if the broadcaster offers this service). Displays for a few seconds when the channel is changed or the DISPLAY button is pressed.	
Label Video Inputs	Allows you to identify A/V equipment you connected to the TV, such as a VCR, DVD, etc. For example, if you have a DVD player connected to the COMPONENT IN jack, you can select the label DVD for the Component input. Then when you press INPUT to change inputs, the video label you assigned to that input appears on screen.	
	<ol style="list-style-type: none"> 1 Press ▲/▼ to highlight the video input (Video 1-2, Component 1-2, HDMI 1-2, PC) to which you want to assign a label. Then press (+) to select the input. 2 Press ▲/▼ to highlight one of the displayed labels. Then press (+) to select the label. 	
	You can select from the following labels for each input:	
	Video 1-2 –, DVD, VCR, Blu-ray, Cable Box, Satellite, DVR, Game, Camcorder, Skip	
	Component 1-2 –, DVD, VCR, Blu-ray, Cable Box, Satellite, DVR, Game, Camcorder, Skip	
	HDMI 1-2 –, DVD, VCR, Blu-ray, Cable Box, Satellite, DVR, Game, Camcorder, Skip	
	PC –, Skip	
	If you select Skip , your TV skips this input when you press the INPUT button.	
	The Skip label is useful for inputs to which no equipment is connected.	
Language	Select to display all on-screen settings in your language of choice: English , Español , Français .	
Sleep Timer	Set the time in minutes (Off , 15 , 30 , 45 , 60 , 90 , or 120) that you want the TV to remain on before shutting off automatically.	

(Continued)

Using the Menus

Option	Description
Power Saving	Select to reduce the power consumption by adjusting the backlight brightness. This also enhances the black level. Select from Off, Low and High.  You can also access Power Saving by using the TOOLS button on the remote control.
Product Information	Select to display the equipment information of your TV.
CineMotion	Select Auto to automatically detect film content and apply a reverse 3-2 pulldown process. Moving pictures will appear cleaner and more natural looking. Select Off to disable the detection.

Programming Closed Captions (CC)

If you selected the Program option under Closed Captions (CC), you can change the following settings:

Option	Description	
Basic	Allows you to select basic analog (EIA-608) closed caption options.	
	CC1, CC2, CC3, CC4	Displays a printed version of the dialogue or sound effects of a program. (Should be set to CC1 for most programs.)
	Text1, Text2, Text3, Text4	Displays network/station information presented using either half or the whole screen (if available).
Digital CC	Allows you to set digital closed captioning to Basic (digital EIA-608) or Advanced (digital EIA-708).	
Advanced	Allows you to select advanced digital (EIA-708) closed caption options. Select from the available options.	
Advanced Settings	Allows you to make additional settings for digital (EIA-708) closed caption options. Select Text, and then select either As Broadcast or Custom.	
	Custom	Allows you to customize the following settings:
	Character Style	Style 1-7
	Character Color	Color 1-8
	Character Size	Small, Standard, Large
	Character Opacity	Solid, Translucent, Transparent, Flashing
	Edge Color	Color 1-8
	Edge Type	None, Raised, Depressed, Uniform, Left Shadow, Right Shadow
	Background Color	Color 1-8
	Background Opacity	Solid, Translucent, Transparent, Flashing
	Window Color	Color 1-8
	Window Opacity	Solid, Translucent, Transparent, Flashing

Other Information

Troubleshooting

If you have additional questions, service needs, or required technical assistance related to the use of your Sony TV, please visit our website or call one of the following numbers:

<<http://www.sony.com/TVsupport>>

1-800-222-SONY(7669) for US Residents

1-877-899-SONY(7669) for Canadian Residents

Problem	Possible Remedies
No picture.	
Cannot receive any channels.	<input type="checkbox"/> Make sure the power cord is connected securely. <input type="checkbox"/> Turn on the power of the TV. <input type="checkbox"/> Check antenna/cable connections.
TV is locked to one channel.	<input type="checkbox"/> Perform Auto Program to add receivable channels that are not presently in the TV's memory (page 29).
Cannot receive or select channels.	<input type="checkbox"/> Perform Auto Program to add receivable channels that are not presently in the TV's memory (page 29). <input type="checkbox"/> To receive or select cable channels, make sure that Cable in the Channel settings is set to On (page 29). To receive or select UHF channels over an antenna, make sure Cable is set to Off .
The TV turns off automatically.	<input type="checkbox"/> Check Power Management in the PC Settings . (page 28)
No picture from some video sources.	<input type="checkbox"/> Check the connection between the optional video equipment and the TV. <input type="checkbox"/> Press INPUT on the remote control (page 23). <input type="checkbox"/> Press MENU on the remote control. Select your desired input from the external inputs list.
Poor picture.	
Double images or ghosts.	<input type="checkbox"/> Check antenna/cable connections. <input type="checkbox"/> Check the antenna location and direction.
Only snow and noise appear on the screen.	<input type="checkbox"/> Check if the antenna is broken or bent. <input type="checkbox"/> Check if the antenna has reached the end of its serviceable life. (3-5 years in normal use, 1-2 years at the seaside.)
Dotted lines or stripes.	<input type="checkbox"/> Keep the TV away from noise sources such as cars, motorcycles, or hair-dryers. <input type="checkbox"/> If using 300 ohm twin lead, move the excess lead away from the TV or try using 75 ohm coaxial cable instead.
No color/Dark picture/Color is not correct/The picture is too bright.	<input type="checkbox"/> Press PICTURE to select the desired picture mode (page 21). <input type="checkbox"/> Adjust the Picture Mode options in the Picture settings (page 25). <input type="checkbox"/> If you set the Power Saving mode to Low or High , it will enhance the black level.
Noisy picture.	<input type="checkbox"/> Make sure that the antenna is connected using the 75-ohm coaxial cable (not supplied). <input type="checkbox"/> Keep the antenna cable away from other connecting cords. <input type="checkbox"/> To avoid TV interference, make sure to use an undamaged antenna cable.

(Continued)

Other Information

Problem	Possible Remedies
No sound/Noisy sound	
Good picture, no sound.	<ul style="list-style-type: none"> <input type="checkbox"/> Check the volume control. <input type="checkbox"/> Press MUTING or VOL + so that “Muting” disappears from the screen (page 21). <input type="checkbox"/> Set Speaker to On in the Sound settings (page 26). If it is set to Off, sound is not output from the TV’s speakers regardless of the TV’s volume control.
Audio noise.	<ul style="list-style-type: none"> <input type="checkbox"/> Make sure that the antenna is connected using the 75-ohm coaxial cable (not supplied). <input type="checkbox"/> Keep the antenna cable away from other connecting cords. <input type="checkbox"/> To avoid TV interference, make sure to use an undamaged antenna cable.
Wide Mode changes automatically.	<ul style="list-style-type: none"> <input type="checkbox"/> The current Wide Mode setting is automatically replaced with the 4:3 Default setting when you change the channel or video input, if 4:3 Default in the Screen settings is set to anything but Off. If you want to lock in the Wide Mode selected with the WIDE button, set 4:3 Default to Off in the Screen settings (page 27). <input type="checkbox"/> Check the Auto Wide option in the Screen settings (page 27).
“Black box” on screen.	<ul style="list-style-type: none"> <input type="checkbox"/> You have selected a text option in the Setup setting and no text is available. (See pages 33 and 34 to reset Setup selections.) To turn off this feature, set the Closed Captions (CC) option to Off. If you were trying to select closed captioning, select CC1 instead of Text1-4.
Black bands appear at the top and bottom of the screen.	<ul style="list-style-type: none"> <input type="checkbox"/> Some wide screen programs are filmed in aspect ratios that are greater than 16:9 (this is especially common with theatrical releases). Your TV will show these programs with black bands at the top and bottom of the screen. For more details, check the documentation that came with your DVD (or contact your program provider).
Certain programs on DVD or other digital sources display a loss of detail, especially during fast-motion or dark scenes.	<ul style="list-style-type: none"> <input type="checkbox"/> The compression used by certain digital broadcasts and DVDs may cause your TV’s screen to display less detail than usual, or cause artifacts (small blocks or dots, pixelations) to appear on your screen. This is due to your TV’s large screen and ability to show very fine detail, and is normal for certain digitally recorded programs.
Remote control does not operate.	<ul style="list-style-type: none"> <input type="checkbox"/> Check the polarity of the batteries or replace the batteries. <input type="checkbox"/> Point the remote control at the remote control sensor of the TV. <input type="checkbox"/> Fluorescent lamps can interfere with your remote control operation; try turning off the fluorescent lamps. <input type="checkbox"/> Keep the remote control sensor area clear from obstacles.
Some digital cable channels are not being displayed.	<ul style="list-style-type: none"> <input type="checkbox"/> Certain cable companies have limitations on the broadcast of digital cable channels. Check with your cable company for more information. <input type="checkbox"/> The digital cable channel may be set to Hidden in the Show/Hide Channels setting (see page 29).
Lost password.	<ul style="list-style-type: none"> <input type="checkbox"/> Select the Parental Lock settings on the settings screen, then enter the following master password: 4357. The master password clears your previous password and allows you to enter a new password (page 31).
How to reset the TV to factory settings.	<ul style="list-style-type: none"> <input type="checkbox"/> Turn on the TV. While holding down the ▲ button on the remote control, press the POWER button on the TV. (The TV will turn itself off, then back on again.) Release the ▲ button. WARNING: The Reset will clear all of your customized settings including Parental Lock setting.

Preparation for Wall Mounting

This TV can be installed on a wall by using a Wall-Mount Bracket (sold separately). Before mounting the TV on a wall, the Table-Top Stand must be removed from the TV.

 Do not remove the Table-Top Stand for any reason other than to wall-mount the TV.

Follow the simple steps below to remove the Table-Top Stand:

- 1** Disconnect all the cables from the TV.
- 2** Secure the Mounting Hook to the rear of the TV.
- 3** Adjust the angle of the Mounting Hook.
- 4** Start removing the screws behind the TV (See illustration below). Do not remove any other screws from the TV.
- 5** When screws are removed, lift the TV off the stand. Make sure that you carry out this task with at least two people. Do not attempt to lift the TV by yourself.

For bracket installation, refer to the instruction guide provided by the Wall-Mount Bracket model for your TV. Sufficient expertise is required in installing this TV, especially to determine the strength of the wall for withstanding the TV's weight. **For product protection and safety reasons, Sony strongly recommends that you use the Wall-Mount Bracket model designed for your TV and the wall-mounting of your TV should be performed by Sony dealers or licensed contractors.**

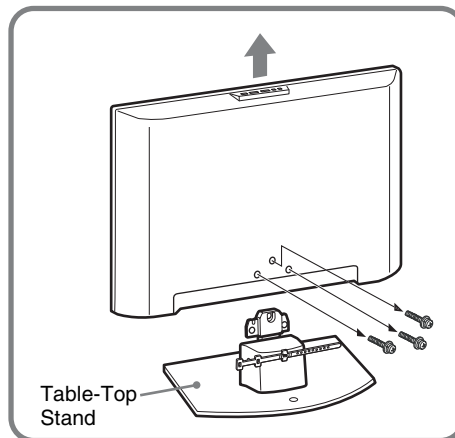

 Be sure to store the removed screws and Table-Top Stand in a safe place until you are ready to reattach the Table-Top Stand. Keep the screws away from small children.

**Sony Wall-Mount
Bracket Model
SU-WL500**

PC Input Signal Reference Chart

Resolution Signals	Horizontal (Pixel)	×	Vertical (Line)	Horizontal frequency (kHz)	Vertical frequency (Hz)	Standard
VGA	640	×	480	31.5	60	VGA
	640	×	480	37.5	75	VESA
	720	×	400	31.5	70	VGA-T
SVGA	800	×	600	37.9	60	VESA Guidelines
	800	×	600	46.9	75	VESA
XGA	1024	×	768	48.4	60	VESA Guidelines
	1024	×	768	56.5	70	VESA
	1024	×	768	60.0	75	VESA
WXGA	1280	×	768	47.4	60	VESA
	1280	×	768	47.8	60	VESA
	1360	×	768	47.7	60	VESA

 This TV's PC input does not support Sync on Green or Composite Sync.

 This TV's PC VGA input does not support interlaced signals.

 For the best picture quality, it is recommended to use the signals from the above chart with a 60 Hz vertical frequency from a personal computer. In plug and play, signals with a 60 Hz vertical frequency will be selected automatically.

Specifications

Television system:

NTSC	American TV standard
ATSC (8VSB terrestrial)	ATSC compliant 8VSB
QAM on cable	ANSI/SCTE 07 2000 (Does not include CableCARD functionality)

Channel coverage:

Terrestrial	Analog	Digital
Cable	2-69	2-69
	1-135	1-135

Antenna: 75-ohm external terminal for VHF/UHF

Panel System:

LCD (Liquid Crystal Display) Panel

Display resolution (horizontal × vertical):

1,366 dots × 768 lines

VIDEO IN 1/2:

S VIDEO (4-pin mini DIN) (VIDEO 1 only):	Y: 1.0 Vp-p, 75 ohms unbalanced, sync negative
	C: 0.286 Vp-p (Burst signal), 75 ohms
VIDEO:	1 Vp-p, 75 ohms unbalanced, sync negative
AUDIO:	500 mVrms (100% modulation)
	Impedance: 47 kilohms

COMPONENT IN 1/2:

YPbPr (Component Video):	Y: 1.0 Vp-p, 75 ohms unbalanced, sync negative
	PB: 0.7 Vp-p, 75 ohms
	PR: 0.7 Vp-p, 75 ohms
	Signal format: 480i, 480p, 720p, 1080i
AUDIO:	500 mVrms (100% modulation)
	Impedance: 47 kilohms

HDMI IN 1/2:

HDMI:	Video: 480i, 480p, 720p, 1080i, 1080p
	Audio: Two channel linear PCM 32, 44.1 and 48 kHz, 16, 20 and 24 bits

AUDIO (HDMI IN 1 only):	500 mVrms (100% modulation)
	Impedance: 47 kilohms

AUDIO OUT:

500 mVrms (100% modulation)

DIGITAL AUDIO OUT (OPTICAL):

Optical Digital Audio Output (PCM/Dolby Digital)

PC IN:

Analog RGB (D-sub 15-pin):	0.7 Vp-p, 75 ohms, positive
See the PC Input Signal Reference Chart on page 38	
AUDIO (Stereo mini jack):	500 mVrms (100% modulation)
	Impedance: 47 kilohms

Power Requirement:

120 V-240 V AC, 50/60 Hz

Screen size (in inches):

32, 37

Speaker/Full range (2):

(in mm)	50 × 115
(in inches)	2 × 4 ³ / ₄

Speaker output:

10 W + 10 W

Power consumption:

KDL-32L4000:	
in use	165 W
in standby	less than 1.0 W
KDL-37L4000:	
in use	190 W
in standby	less than 1.0 W

Dimensions:

KDL-32L4000:	
with stand:	
(in mm)	807 × 585 × 242
(in inches)	31 ⁷ / ₈ × 23 ¹ / ₈ × 9 ⁵ / ₈
without stand:	
(in mm)	807 × 548 × 101
(in inches)	31 ⁷ / ₈ × 21 ⁵ / ₈ × 4
KDL-37L4000:	
with stand:	
(in mm)	933 × 653 × 276
(in inches)	36 ³ / ₄ × 25 ³ / ₄ × 10 ⁷ / ₈
without stand:	
(in mm)	933 × 616 × 112
(in inches)	36 ³ / ₄ × 24 ³ / ₈ × 4 ¹ / ₂

Mass:

KDL-32L4000:	
with stand:	
(in kg)	16.0
(in lb.)	35 lb 5 oz
without stand:	
(in kg)	13.8
(in lb.)	30 lb 7 oz
KDL-37L4000:	
with stand:	
(in kg)	21.2
(in lb.)	46 lb 12 oz
without stand:	
(in kg)	18.2
(in lb.)	40 lb 2 oz

Supplied accessories:

Remote control RM-YD025	(1)
Size AA batteries	(2)
AC power cord	(1)
Table-Top Stand	(1)
Screws	(3)
Cable band	(1)
Operating Instructions	(1)
Quick Setup Guide	(1)
Warranty Card	(1)
Online Registration Card	(1)
Open-source software flyer	(1)

Optional accessories:

Connecting cables	
Support belt kit	
Wall-Mount Bracket:	SU-WL500
TV-Stand:	
KDL-32L4000:	SU-FL300M
KDL-37L4000:	SU-FL300M

 Optional accessories availability depends on its stock.

Design and specifications are subject to change without notice.

0 - 9 buttons 23
4:3 Default 27

A

AC IN 16
Advanced 34
Advanced Settings 34
Alternate Audio 26
AUDIO OUT jack, described 16
Auto Adjustment 28
Auto Program 20, 29
Auto Wide 27

B

Backlight 25
Balance 26
Basic 34
Bass 26
Brightness 25

C

Cable 29
CABLE/ANTENNA input, described 16
CC button 21
CH+/- button 23, 24
Change Password 31
Channel Block 30
Channels
 Creating labels 33
 Setting up 20
CineMotion 34
Closed caption modes 33, 34
Closed Captions (CC) 33
Color 25
Color Temp 25
COMPONENT IN
 (1080i/720p/480p/480i) 16

D

Diagnostics 29
Digital CC 34
Digital Channels 29
DIGITAL OUT OPTICAL 16
Digital Rating 30
DISPLAY button 21

E

English Rating 32
ENT button 23
External Input Block 31

F

Favorites 29
FAVORITES button 21
French Rating 32

H

HDMI IN jack, described 15
Horizontal Center 28
Hue 25

I

Info Banner 33
Infrared Receiver (IR) 24
INPUT button 23, 24
Installing the TV on a wall 37

J

JUMP button 23

L

Label Channels 29
Label Video Inputs 33
Language 33

M

MENU button 21, 24
Movie Rating 31
MTS 26
MUTING button 21

N

Noise Reduction 25

P

PC IN 16
Phase 28
Picture 25
PICTURE button 21
Picture Mode 25
Pitch 28
POWER button 22, 24
POWER LED 24
Power Management 28
Power Saving 34
Product Information 34

R

Rating 30
Reset 25, 26, 36
RETURN button 21

S

S VIDEO jack, described 16
Select Country 31
Settings
 Channel 29
 Parental Lock 30
 PC Settings 28
 Picture 25
 Screen 27
 Setup 33
 Sound 26
Sharpness 25
Show/Hide Channels 29
SLEEP button 21
Sleep Timer 33
Sound Mode 26
Speaker 26
STANDBY LED 24

T

TIMER LED 24
TOOLS button 23
Treble 26
Troubleshooting 35, 36
TV Rating 31

U

U.S.A. Rating 32
Unrated 30

V

Vertical Center 28
VIDEO/AUDIO (L/R) jacks, described
 15, 16
Viewing Blocked Programs 32
VOL+/- button 21, 24

W

WIDE button 22
Wide Mode 27, 28

For Your Convenience

Please contact Sony directly if you:

- Have questions on the use of your television after reading your Operating Instruction manual and Quick Setup Guide
- Experience difficulty operating your television

Contact Sony Customer Support at:

<http://www.sony.com/tvsupport>

or to speak with a support representative:

United States

1-800-222-SONY (7669)

Canada

1-877-899-SONY (7669)

Sony will work to resolve your questions more quickly than your retailer or place of purchase.

Please Do Not Return the Product to the Store